

Specifications:

plug description (1)	Ø2.1 x 5.5 x 30 ± 0.5, black insulator, P/N 50-00010
plug overmold (2)	30P, PVC, black
cable description (3)	UL1185, 0.16 x 41 strands, shield wire, 1F
cable outer diameter	Ø3.4 ± 0.1
cable color	black
cable gauge	AWG #18
cable length	2000 ± 50
twist tie (4)	black, 89 ± 3, non-toxic
rated load	12 Vdc @ 5 A

Notes:

Function test: no open, no reversed polarity, no short circuit, no INT
 Hi-POT test: 600 Vac, 0.5 mA, 1 sec.
 RoHS compliant

Mechanical drawing:

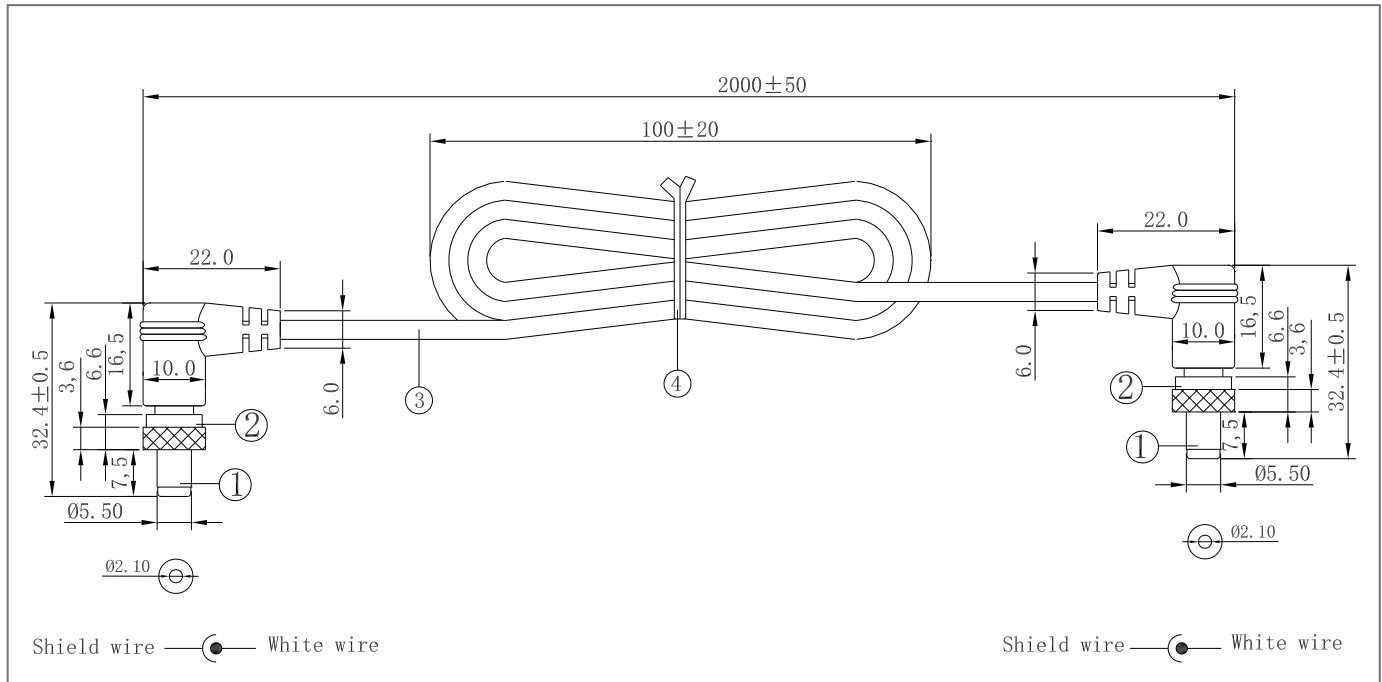

Initial	Date
---------	------

tolerance X: ±0.5 mm .X: ±0.3 mm .XX: ±0.05 mm

Cable specifications:

conductors

gauge	18 AWG
material	brass copper
cord size	41/0.16 TC

insulation

material	F0040C 50PB (4370) UL 80°C
color	white
diameter	Ø1.60 ± 0.05

jacket

material	F0208C 60P (4026) UL 80°C
color	black
diameter	Ø3.4 ± 0.10

electrical & physical properties

spiral shield	41/0.16 TC
rated voltage	300 V
rated temperature	80 °C
insulation resistance	0.76 (15.6 °C) mΩ / m min.
resistance @ 20 °C	21.8 mΩ/m max

material		insulation	jacket
unaged	tensile strength (kfg/mm ² min)	1.05	1.05
	elongation (%min)	100	100
aging test	condition	113°C/168 h	113°C/168 h
	elongation (% unaged min)	65	65
	tensile strength (% unaged min)	75	75
deformation (121± 1 °C x 1 hour)		≤50%	≤50%
cold bend (-10 ± 1 °C x 1 hour)		OK	OK
heat shock (121 ± 1 °C x 1 hour)		OK	OK
flame test		VW-1	VW-1

Cable cross section:

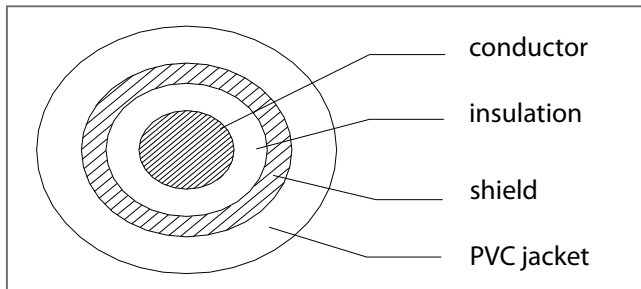

Revision notes:

Rev	Date	Description
A	May 28, 2009	initial release

Specification Approval

Spec sign-off verifies that you have reviewed the entire specification, tested a sample of the product, and confirm that it meets your requirements. This specification reflects the part as it will be ordered. Orders will not be processed until the specification pages have been initialed and the approval page has been signed. This specification is confidential and is not to be transmitted without prior approval from Tensility.

Signature _____

Title _____

Name _____

Date _____